

Name

Pinokkio 115x179_16

Zeichnung/Drawing

3D

Profil/Profile

1.6x11.3

Datum/Date

20.01.2017

WAND / WALL 1

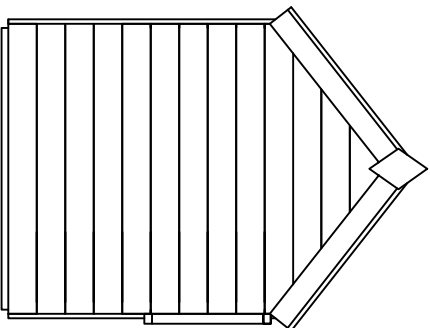

WAND / WALL 2

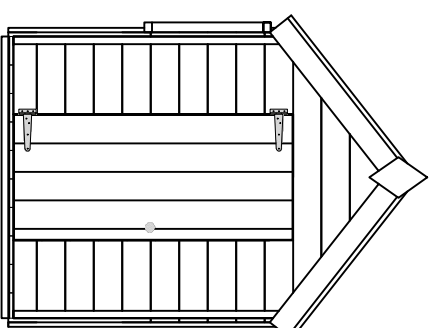

WAND / WALL A

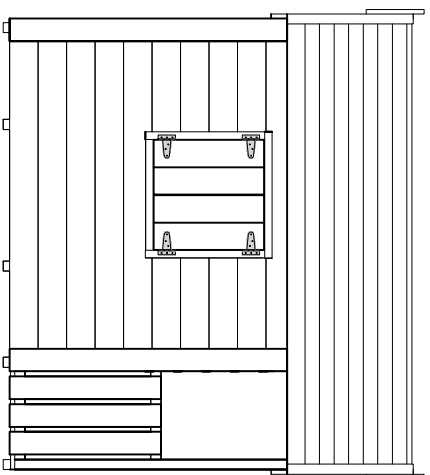

WAND / WALL B

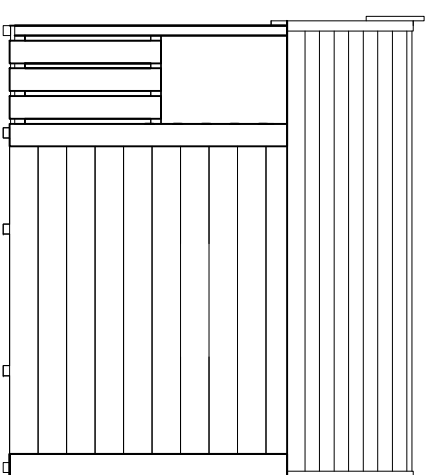

Name

Pinokkio 115x179_16

Zeichnung/Drawing

WAND/WALL

Profil/Profile

1.6x11.3

Datum/Date

20.01.2017

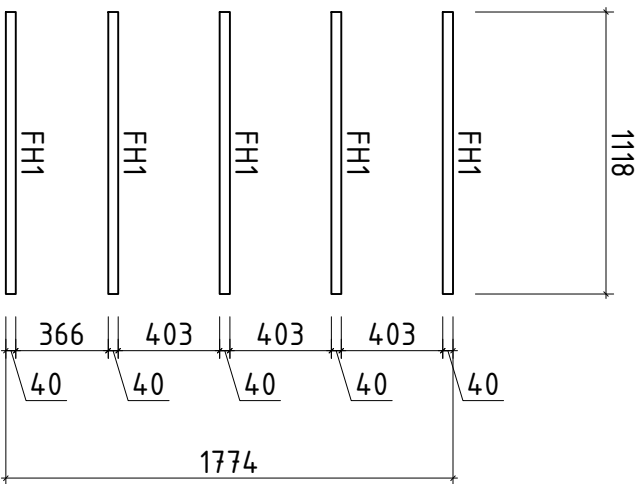
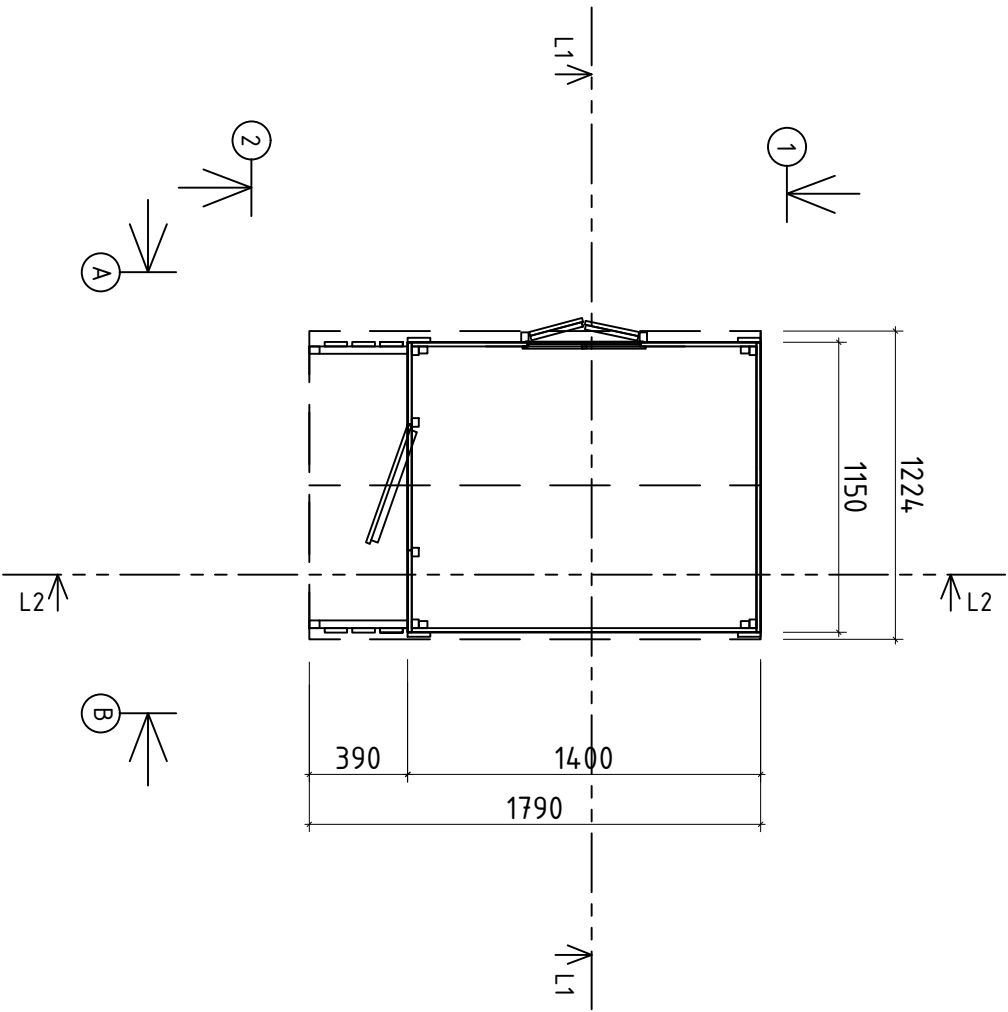

Name	Pinokkio 115x179_16	
Zeichnung/Drawing	Grundplan_Plan, Lagerholzplan_Foundation beams	
Profil/Profile	1.6x11.3	Datum/Date
		20.01.2017

L1-L1

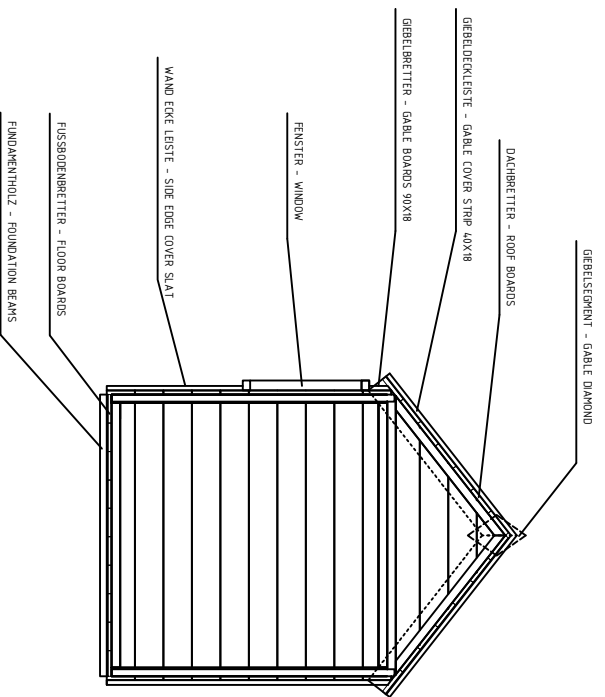



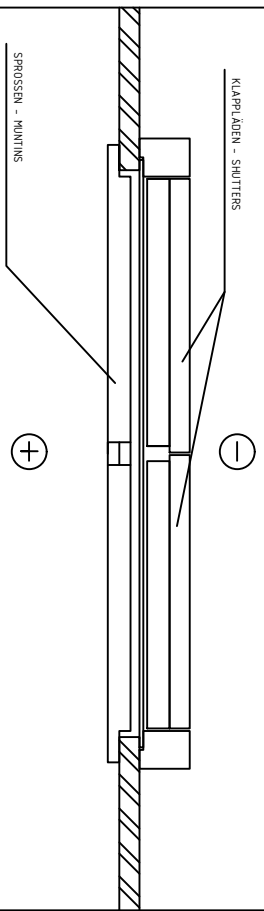

FENSTER - WINDOW

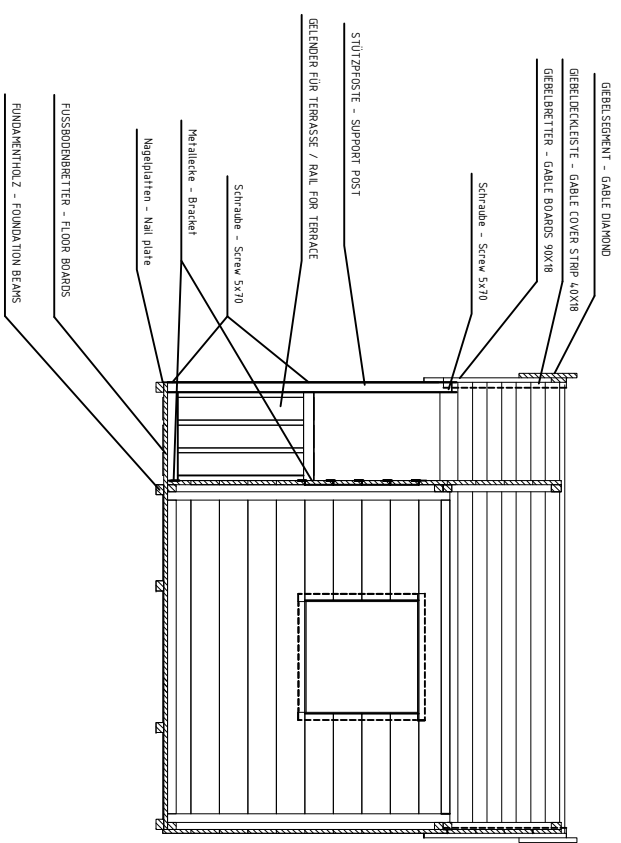



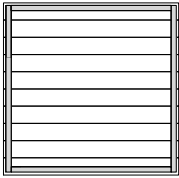
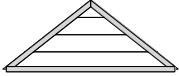
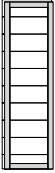
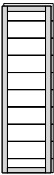
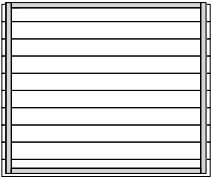
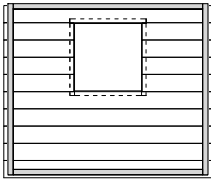
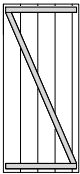









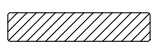

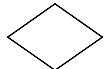
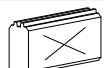
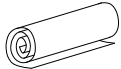

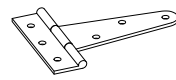
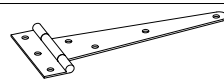

L2-L2

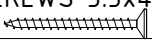

Name	Pinokkio 115x179_16
Zeichnung/Drawing	Schnitt / Section
Profil/Profile	1.6x11.3
Datum/Date	20.01.2017

Pos	Teilelist/specification Pinokkio 115x179_16		Stck. Pcs.	Profil Profile (mm)	Länge Length (mm)
EL1	Wand / Wall 1		1	1150x1130	
EL2	Wand / Wall 1 Wand / Wall 2		2	1150x469	
EL3	Wand / Wall 2		1	335x1110	
EL4	Wand / Wall 2		1	335x1110	
EL5	Wand / Wall B		1	1368x1142	
EL6	Wand / Wall A mit Fenster / with Window		1	1368x1142	
EL7	Tür / Door 495x1105		1	495x1105	
EL8	Gelender für Terrasse / Rail for Terrace		2	350x600	
EL9	Klappläden / Shutters		2	216x438	
FH1	Fundamentholz (imprägniert) - Foundation Beam (impregnated)		5	40x30	1118
LE1	Stützpfoste - Support post		2	40x30	1146
	38.2°				
Kood	Pinokkio 115x179_16	Materjal	File	Pinokkio 115x140_16 KLIENT	1/2

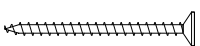
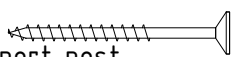
Pos	Teilelist/specification Pinokkio 115x179_16		Stck. Pcs.	Profil Profile (mm)	Länge Length (mm)	
LE3	Wand ecke leiste - Side edge cover slat 		✓	4	90x18	1130
	SPROSSEN - MUNTINS			1+1	18x18	490
	FUSSBODENBRETTER - FLOOR BOARDS		✓	10	113x16	1774
	DACHBRETTER - ROOF BOARDS		✓	14	113x16	1790
G2-1	GIEBELBRETTER - GABLE BOARDS 90X18	 38.2°	✓	4	90x18	870
G6-1	GIEBELDECKLEISTE - GABLE COVER STRIPS 40X18		✓	4	40x18	870
GS	GIEBELSEGMENT - GABLE DIAMOND			2		
SH	SCHLAGHÖLZER - MOUNTING PIECES			3		
	DACHPAPPE - ROOFING FELT		✓		1.8m-2st	3.6 lfm/rm
TK2	TÜRGRIFF klein - KNOB small			2		
ME	METALLECKE - BRACKET 20x20x40			4		
NP02	NAGELPLATTEN - NAIL PLATE 80x30			2		
S01	SCHARNIER - HINGE 75x63 Klappläden - Shutters			4		
S02	SCHARNIER - HINGE 150x63 Tür - Door			2		
H1	HAAKEN - WIRE HOOK			2		
NG3	DACHPAPPNÄGEL - ROOFING NAILS 2.0x18			60		
NG4	NÄGEL - NAILS 2.0x40 Pörandalud Katuselaud			156		
SR23	SCHRAUBEN - SCREWS 3.0x20 Akna prossid			4		
SR16	SCHRAUBEN - SCREWS 3.5x25	Metalecke - Bracket (4x4stck/pcs) Nagelplatten - Nailplates (6x2stck/pcs) Türgriff - Knob (6x2stck/pcs) Giebeldeckleiste - Gable cover strip (12stck/pcs) Scharnier - Hinge (4x6stck/pcs + 2x7stck/pcs)		72		
SR03	SCHRAUBEN - SCREWS 3.5x45	Giebelbretter - Gable board (12stck/pcs) Giebelsegment - Gable diamond (2stck/pcs) Wand ecke leiste - Side edge cover slat (12stck/pcs)		26		
SR17	SCHRAUBEN - SCREWS 4.0x50 Element 2 Terrasse galender - ferrace rail			10		
SR05	SCHRAUBEN - SCREWS 4.0x60 Element 1, 3, 4, 5, 6			28		
SR10	SCHRAUBEN - SCREWS 5.0x70 Stützpfoste - support post			6		
	✓ - Bitte selber anpassen (falls nötig)! / Cut into length on site (if needed)!					
Kood	Pinokkio 115x179_16	Materjal	File	Pinokkio 115x140_16 KLIENT.	dwgt	2/2

1.

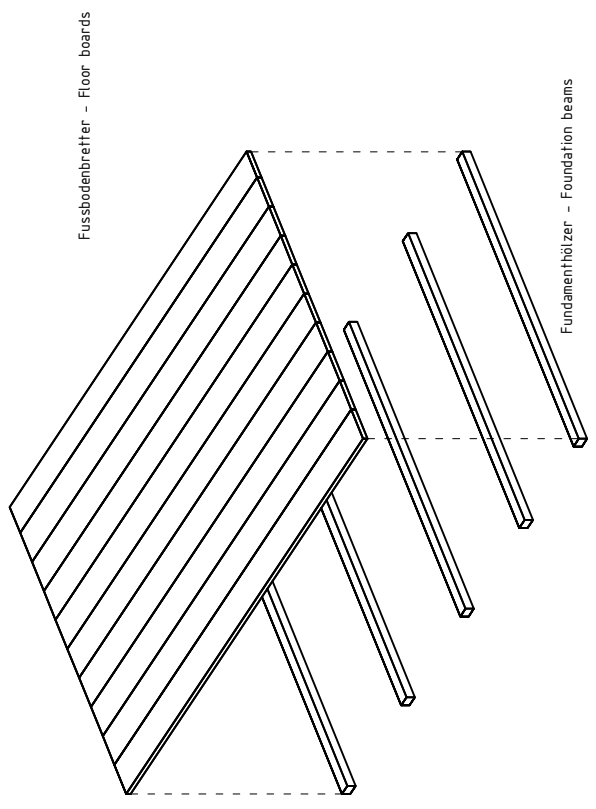

2.

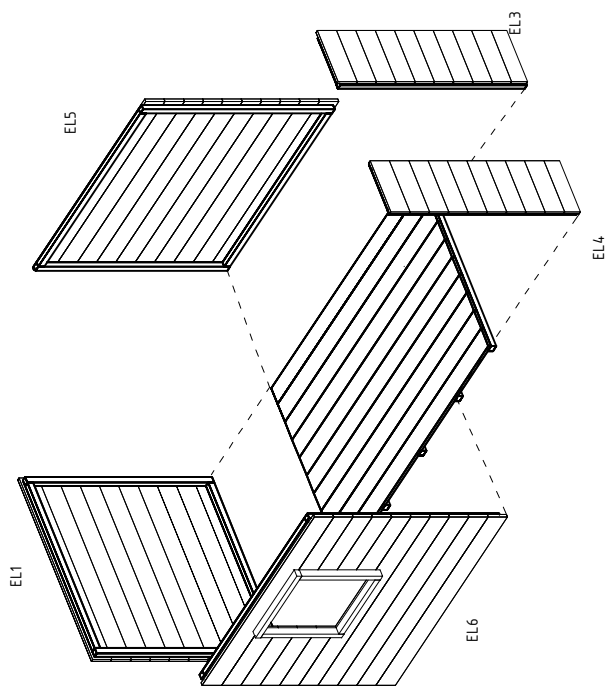

3.

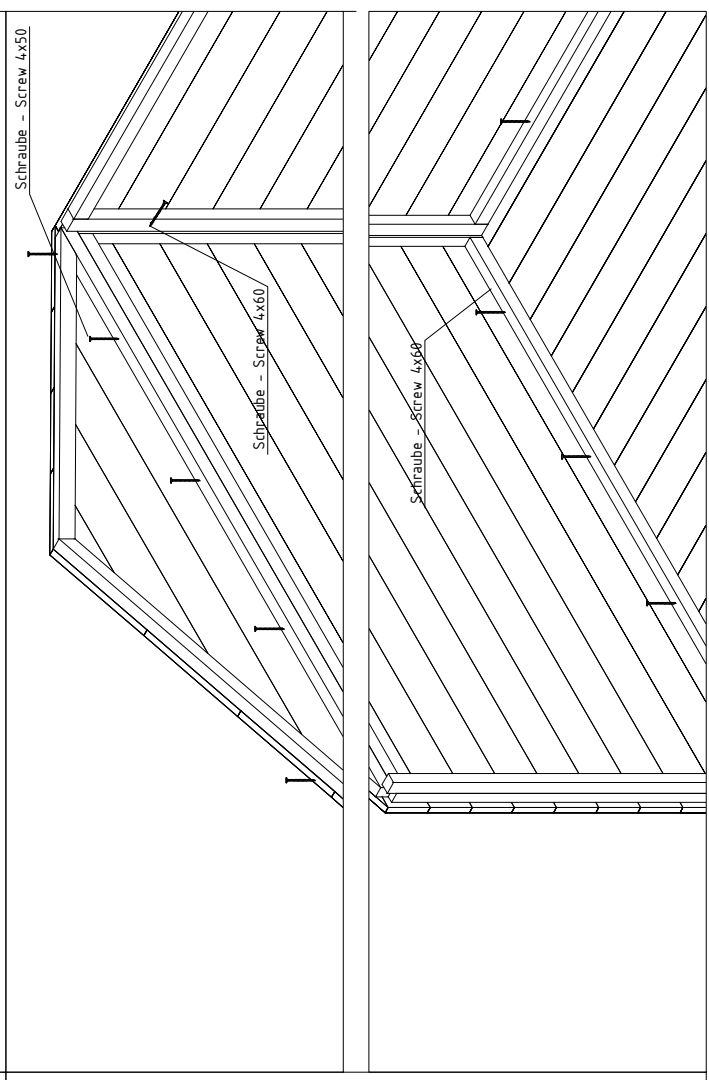
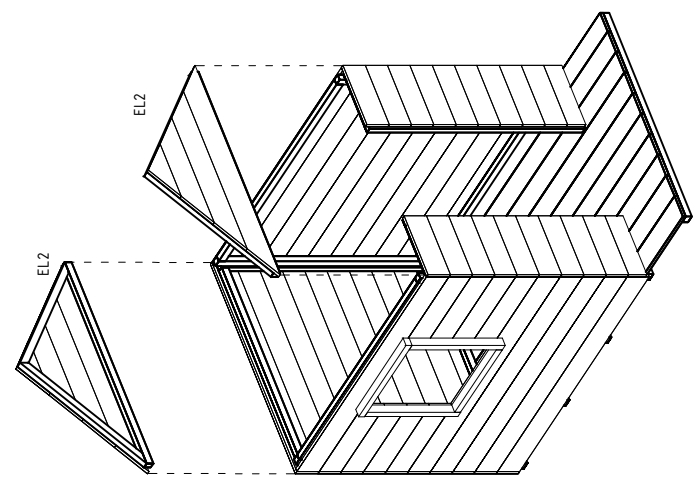

4.

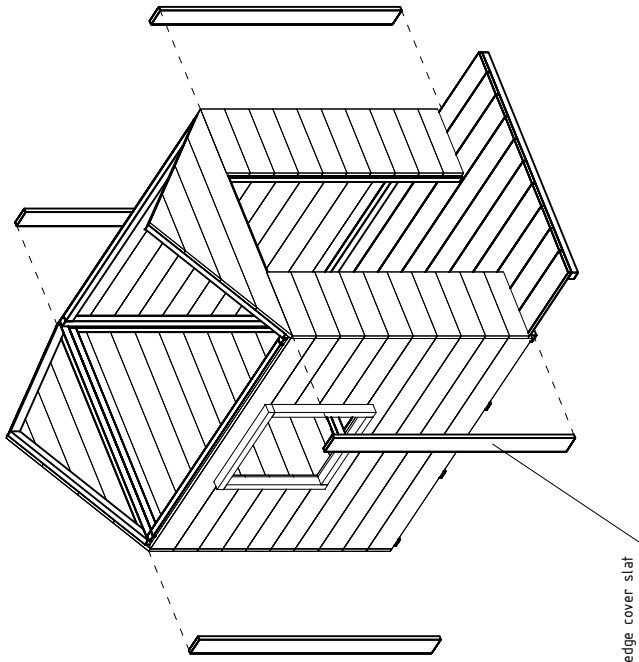

Wand ecke leiste - Side edge cover slat

5.

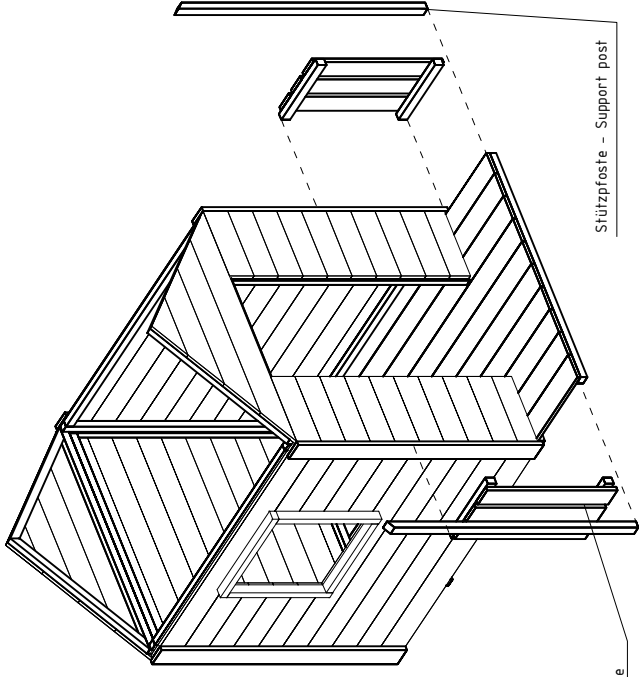

Geländer für Terrasse-Rail for Terrace

Stützpfoste - Support post

6.

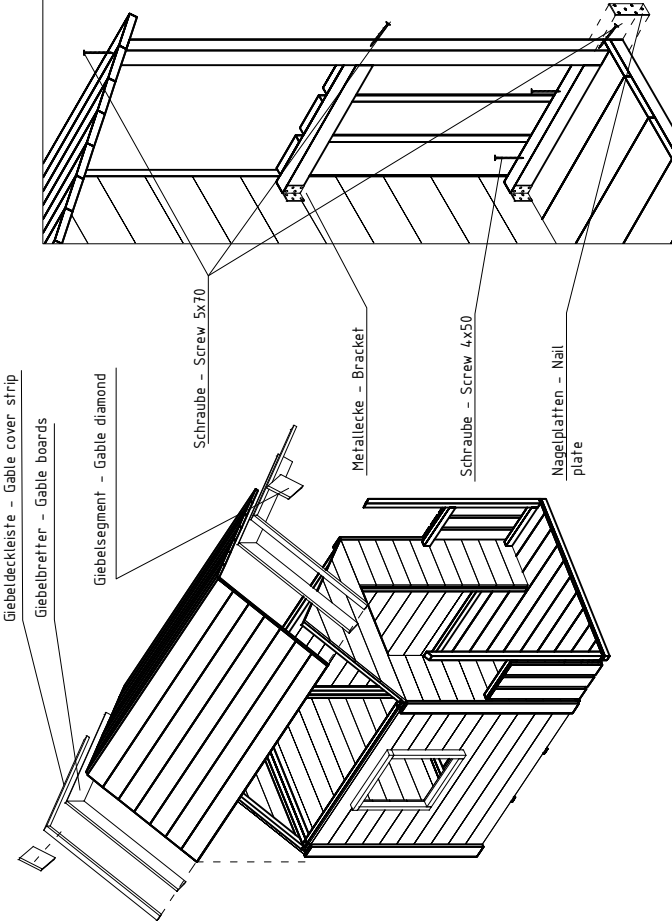

Giebeldeckleiste - Gable cover strip

Giebelbretter - Gable boards

Giebelsegment - Gable diamond

Schraube - Screw 5x70

Metallecke - Bracket

Schraube - Screw 4x50

Nagelplatten - Nail plate

7.

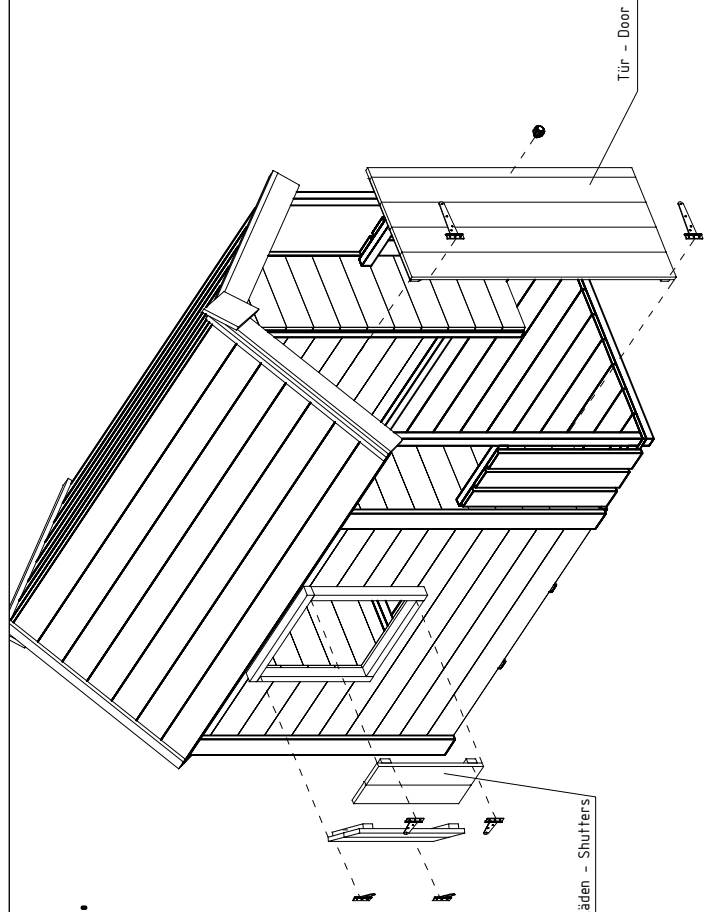

Klappläden - Shutters

Tür - Door